

G-Sharp

DUAL ENGINE GUITAR FX PROCESSOR



USER'S MANUAL

IMPORTANT SAFETY INSTRUCTIONS



The lightning flash with an arrowhead symbol within an equilateral triangle, is intended to alert the user to the presence of uninsulated "dangerous voltage" within the product's enclosure that may be of sufficient magnitude to constitute a risk of electric shock to persons.



The exclamation point within an equilateral triangle is intended to alert the user to the presence of important operating and maintenance (servicing) instructions in the literature accompanying the product.

- 1 Read these instructions.
- 2 Keep these instructions.
- 3 Heed all warnings.
- 4 Follow all instructions.
- 5 Do not use this apparatus near water.
- 6 Clean only with dry cloth.
- 7 Do not block any ventilation openings. Install in accordance with the manufacturer's instructions.
- 8 Do not install near any heat sources such as radiators, heat registers, stoves, or other apparatus (including amplifiers) that produce heat.
- 9 Do not defeat the safety purpose of the polarized or grounding-type plug. A polarized plug has two blades with one wider than the other. A grounding type plug has two blades and a third grounding prong. The wide blade or the third prong are provided for your safety. If the provided plug does not fit into your outlet, consult an electrician for replacement of the obsolete outlet.
- 10 Protect the power cord from being walked on or pinched particularly at plugs, convenience receptacles, and the point where they exit from the apparatus.
- 11 Only use attachments/accessories specified by the manufacturer.
- 12  Use only with the cart, stand, tripod, bracket, or table specified by the manufacturer, or sold with the apparatus. When a cart is used, use caution when moving the cart/apparatus combination to avoid injury from tip-over.
- 13 Unplug this apparatus during lightning storms or when unused for long periods of time.
- 14 Refer all servicing to qualified service personnel. Servicing is required when the apparatus has been damaged in any way, such as power-supply cord or plug is damaged, liquid has been spilled or objects have fallen into the apparatus, the apparatus has been exposed to rain or moisture, does not operate normally, or has been dropped.

Warning!

- To reduce the risk of fire or electrical shock, do not expose this equipment to dripping or splashing and ensure that no objects filled with liquids, such as vases, are placed on the equipment.
- This apparatus must be earthed.
- Use a three wire grounding type line cord like the one supplied with the product.
- Be advised that different operating voltages require the use of different types of line cord and attachment plugs.
- Check the voltage in your area and use the correct type. See table below:

Voltage	Line plug according to standard
110-125V	UL817 and CSA C22.2 no 42.
220-230V	CEE 7 page VII, SR section 107-2-D1/IEC 83 page C4.
240V	BS 1363 of 1984. Specification for 13A fused plugs and switched and unswitched socket outlets.

- This equipment should be installed near the socket outlet and disconnection of the device should be easily accessible.
- Do not install in a confined space.
- Do not open the unit - risk of electric shock inside.

Caution:

You are cautioned that any change or modifications not expressly approved in this manual could void your authority to operate this equipment.

Service

- There are no user-serviceable parts inside.
- All service must be performed by qualified personnel.

IMPORTANT SAFETY INSTRUCTIONS

EMC / EMI.

This equipment has been tested and found to comply with the limits for a Class B Digital device, pursuant to part 15 of the FCC rules. These limits are designed to provide reasonable protection against harmful interference in residential installations. This equipment generates, uses and can radiate radio frequency energy and, if not installed and used in accordance with the instructions, may cause harmful interference to radio communications. However, there is no guarantee that interference will not occur in a particular installation. If this equipment does cause harmful interference to radio or television reception, which can be determined by turning the equipment off and on. The user is encouraged to try to correct the interference by one or more of the following measures:

- Reorient or relocate the receiving antenna.
- Increase the separation between the equipment and receiver.
- Connect the equipment into an outlet on a circuit different from that to which the receiver is connected.
- Consult the dealer or an experienced radio/TV technician for help.

For the customers in Canada:

This Class B digital apparatus complies with Canadian ICES-003.
Cet appareil numérique de la classe B est conforme à la norme NMB-003 du Canada.

Certificate Of Conformity

TC Electronic A/S, Sindalsvej 34, 8240 Risskov, Denmark, hereby declares on own responsibility that following products:

G-Sharp

DUAL ENGINE GUITAR FX PROCESSOR

- that is covered by this certificate and marked with CE-label conforms with following standards:

- | | |
|----------------------|---|
| EN 60065 (IEC 60065) | Safety requirements for mains operated electronic and related apparatus for household and similar general use |
| EN 55103-1 | Product family standard for audio, video, audio-visual and entertainment lighting control apparatus for professional use. Part 1: Emission. |
| EN 55103-2 | Product family standard for audio, video, audio-visual and entertainment lighting control apparatus for professional use. Part 2: Immunity. |

With reference to regulations in following directives:
73/23/EEC, 89/336/EEC

Issued in Risskov, May 2006
Mads Peter Lübeck
Chief Executive Officer

TABLE OF CONTENTS

INTRODUCTION

<i>Table of Contents</i>	3
<i>Introduction</i>	5
<i>Front Panel Overview</i>	6
<i>Rear Panel Overview</i>	8
<i>Signal Flow Diagram</i>	9

OPERATION

Basics

<i>Connecting and setting up G-Sharp</i>	10
<i>Controlling G-Sharp</i>	10
<i>Routings</i>	10
<i>General Advice</i>	11
<i>Typical Setups</i>	12

Operating G-Sharp

<i>Input/Output Section</i>	16
<i>The Effects engine</i>	17
<i>The Reverb engine</i>	19
<i>Store</i>	20
<i>Recall</i>	20
<i>The Display</i>	20

Miscellaneous

<i>Factory Presets</i>	21
<i>MIDI channel</i>	21
<i>Sysex ID</i>	21
<i>G-Sharp software</i>	21

Effects

<i>Delay</i>	22
<i>Soft Delay</i>	22
<i>Tape Delay</i>	22
<i>Lo-Fi Delay</i>	22
<i>Dynamic Delay</i>	22
<i>PingPong Delay</i>	22
<i>SlapBack Delay</i>	22
<i>Delay Spill-over feature</i>	22

<i>Vintage Phaser</i>	23
<i>Smooth Phaser</i>	23
<i>Swell Tremolo</i>	23
<i>Hard Tremolo</i>	23
<i>Vibrato</i>	23
<i>Flange</i>	23
<i>Lush Chorus</i>	23
<i>Soft Chorus</i>	23

Reverbs

<i>TC Classic Hall</i>	24
<i>Pro Studio</i>	24
<i>Classic Spring</i>	24
<i>Vintage Spring</i>	24
<i>Plain Spring</i>	24
<i>Gold Plate</i>	25
<i>Silver Plate</i>	25
<i>Tin Plate</i>	25
<i>Ambience</i>	25
<i>Stomp</i>	25
<i>Club</i>	25
<i>Soft Room</i>	25
<i>Tiled Room</i>	25
<i>Church</i>	25
<i>Concert Hall</i>	25

APPENDIX

<i>MIDI Implementation Chart</i>	26
<i>MIDI Continuous Controllers</i>	27
<i>MIDI Bulk Dump</i>	27
<i>Reset Procedure</i>	27
<i>Troubleshooting</i>	28
<i>Technical Specifications</i>	29

QUICK START - IF YOU JUST CAN'T WAIT

If you just can't wait to hear the great effects waiting for you in your new G-Sharp Guitar Effects processor just follow the few steps in this quick setup guide:

- Unpack the G-Sharp and check for possible damages that could have been caused by transport.
- Read the safety instructions.
- Take a few minutes to register online via: www.tcelectronic.com or send in the registration card. Customers registered online will be notified directly via e-mail about news regarding TC Electronic guitar products.

G-Sharp is a dedicated guitar effects processor able to combine various modulation and delay effects with high quality reverbs that are especially fine-tuned for guitar applications.

Routings

G-Sharp has two routing options. Serial and Parallel. The Routing mode is set on the G-Sharp front panel.

- When the PARALLEL mode LED is lit - parallel mode is selected.
- When the PARALLEL mode LED is "off" - serial mode is selected.

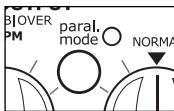

Serial Mode (LED is off)

- utilizing both effect engines in serial where reverb is added to the selected effects.

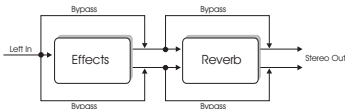

Parallel mode (LED is lit)

- where the inputs are fed to both the Effects and the Reverb engine at the same time thereby letting the two effect blocks run in parallel.

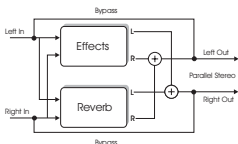

For detailed explanations on Routings and connections please read page 10-11.

- Make all audio connections, - then connect power. See the manual section "Typical Setups" if necessary.
- Killdry on or off? - If the G-Sharp is connected in a parallel loop on a guitar amplifier you should activate the Killdry mode via the switch on the rear panel.
- Set the G-Sharp in Preset Off mode using the PRESET ON/OFF key:

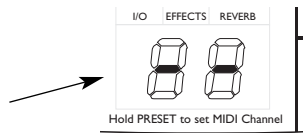

The G-Sharp is in Preset Off mode when the display reads as illustrated above.

- Set all controls in 12 o'clock position to hear factory settings.
- Select an effect from the Effects engine.
- Select a reverb type from the Reverb engine.
- Start playing.
- Adjust input level to a level where the INPUT PPMs only occasionally turn red. When setting the input level we recommend using sound with high dynamic content such as a clean sound.
- Set the EFFECTS mix and REVERB MIX to "normal"
- Now tweak the controls for the two engines until you have the effects intended.

For any questions left unanswered by this manual feel free to visit our online support center; **TC Support Interactive**, which can be accessed via: www.tcelectronic.com



Latest manual revision can always be downloaded from www.tcelectronic.com Manual revision number is found in the bottom of page 3.

INTRODUCTION

Congratulations on the purchase of your TC Electronic G-Sharp guitar effects processor. G-Sharp is a Dedicated Dual Engine Guitar effects unit offering a combination of the best from TC's pristine modulation, delay and reverb libraries, based on ultimate effects algorithms. All effects have been carefully voiced specifically for guitar applications.

We have packed the G-Sharp with "TC goodies" and you'll find high density 24-bit processing and AD/DA converters that fully live up to the TC reputation of high quality effects with no loss of your beloved tone.

With G-Sharp you get full and direct access to a selection of legacy TC reverbs and effects and their key parameters. Ideal settings are easily obtained from the front panel giving you a maximum of flexibility – at home, when rehearsing or when playing live.

Though easy operation with only few essential controls is a key feature, G-Sharp will integrate perfectly in all levels of setups. Use a G-Switch, a TC G-Minor or a conventional MIDI pedal for preset recall, tap tempo and bypass functions and you are in full control.

The adaptive built in power supply, secures seamless operation at any mains voltage (100-240VAC).

Be Sharp with G-Sharp!

Engine 1

- Delay
- Soft Delay
- Tape Delay
- Lo-Fi Delay
- Dynamic Delay
- PingPong Delay
- SlapBack Delay
- Vintage Phaser
- Smooth Phaser
- Swell Tremolo
- Hard Tremolo
- Vibrato
- Flange
- Lush Chorus
- Soft Chorus
- Off



Engine 2

- TC Classic Hall
- Pro Studio
- Classic Spring
- Vintage Spring
- Plain Spring
- Gold Plate
- Silver Plate
- Tin Plate
- Ambience
- Stomp
- Club
- Soft Room
- Tiled Room
- Church
- Concert Hall
- Off

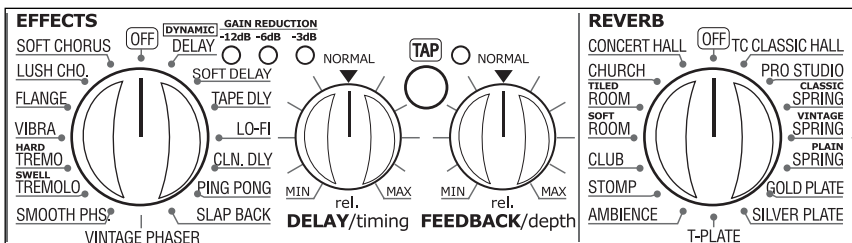

FRONT PANEL OVERVIEW

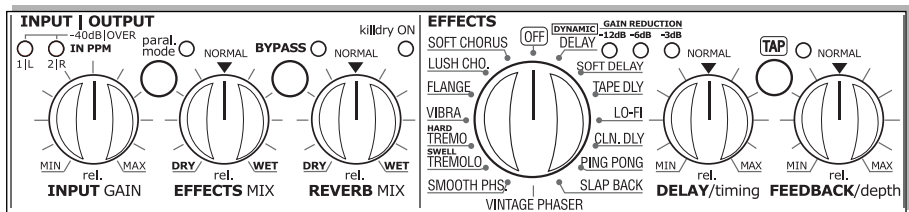

INPUT GAIN

Adjusts the Input gain.

1/L and 2/R LEDs

3 color LEDs indicating Input level on Left and Right Inputs.

- Green: -40dB
- Yellow: -6dB
- Red: -1dB

EFFECTS MIX

Adjusts the mix between the wet and the dry signal for the Effects engine.

REVERB MIX

Adjusts the mix between the wet and the dry signal for the Reverb engine.

Serial mode/Parallel mode

In Serial mode the signal passes the Effects engine before the Reverb engine. In Parallel mode the signal is processed by both engines in parallel. - Which routing to use is a matter of taste and application. Read more about routings on pages 10-11.

BYPASS button and LED

Bypass function varies depending on the selected Killdry mode.

Killdry "on":

The BYPASS key operates as a mute function.

Killdry "off":

The bypass function simply passes the source signal unprocessed to output.

EFFECTS selector

Selects between the 15 effects & Off in the Effects engine.

DELAY/TIMING

Tap the global tempo using the TAP key by tapping quarter notes. Now use the timing knob to multiply the tapped tempo.

The Timing range can be set from 0.5 to 2.

Example:

- Tap quarter notes at Tempo 120 BPM. This equals 500 milliseconds.
- The range of the TIMING knob is 0.5 to 2 giving you a Delay time varying from: 250ms to 1000ms.
Note that the Slapback Delay type has a shorter range, as this Delay type by nature is a short Delay.

FEEDBACK/DEPTH

Controls the Feedback or Depth parameter depending of the selected effect.

- Delay : Feedback
- Phaser : Depth
- Tremolo : Depth
- Flange : Depth
- Chorus : Depth

GAIN REDUCTION

-3, -6, -12 LEDs

These LEDs indicate the applied gain-reduction on the delay repeats when Dynamic Delay type is selected.

FRONT PANEL OVERVIEW

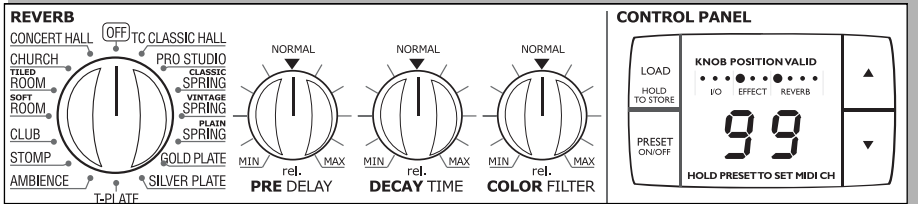

REVERB selector

Selects between 15 different Reverb types or sets the Reverb engine to "Off".

The range of the pre delay and decay time varies depending on the selected reverb type.

PRE DELAY

Controls the pre delay time of the selected reverb.

DECAY TIME

Controls the decay time of the selected reverb.

COLOR FILTER

Controls the color amount of the selected reverb.

LOAD/HOLD TO STORE key

This key has two functions.

- Press once to load the preset selected via the CURSOR UP/DOWN keys.
- Press and hold to store the current preset.

PRESET ON/OFF key

The G-Sharp has two preset modes.

Preset "Off" mode:

The display reads "- -".

In this mode the G-Sharp will play effects according to the front panel controls.

When switching from Preset "On" to Preset "Off" mode the effects will always be updated according to the positions of the front controls.

Preset "On" mode:

The display reads a specific preset number.

In this mode you can recall presets by using the UP/DOWN arrows followed by LOAD. (Note that G-Sharp holds no stored factory presets apart from the default settings in the various effect combinations).

Toggling between the Preset On/Presets Off modes generates two situations:

From "On" to "Off":

Presets are updated according to the positions of the front controls.

CONTROL PANEL

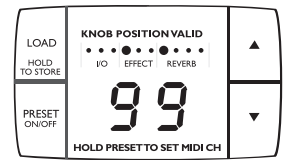

From "Off" to "On":

The display starts to flash the previously recalled preset number while still processing according to the front controls. To actually load the preset press LOAD.

Set MIDI channel

Press and hold the PRESET ON/OFF key for approx. 2.5 sec.

Now set the desired MIDI channel using the ARROW UP/DOWN keys. Options are:

- Channel 1 to 16
- "o" for OMNI (receives on all channels)
- "OF" for Off.

Via this menu a Bulk Dump on MIDI out for preset backups on a standard MIDI sequencer can also be performed.

Press PRESET ON/OFF key once to exit the MIDI channels set mode.

"KNOB POSITIONS VALID" LEDs

The LEDs are relevant in Preset "On" mode only. When lit they indicate when the front panel controls match the settings in the actually recalled preset.

ARROW UP/DOWN keys

Scroll between presets when in Preset "On" mode.

REAR PANEL

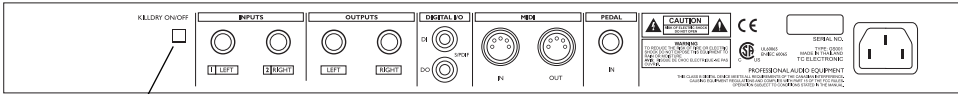

KILLDRY switch

Balanced Jack Analog Inputs

Balanced Jack Analog Outputs

Digital S/PDIF Input/Output

MIDI In/Out

Pedal Input

Power Input 100 - 240VAC

KILLDRY switch

With the switch in "in" position, no clean signal passes through the G-Sharp. This is the setting to use if you connect G-Sharp in a parallel loop or e.g. in an aux send/return on a mixer.

Analog Input

Analog Input on 1/4 inch connectors. Use Left Input only to connect a mono signal.

Analog Output

Analog output is a stereo output on two 1/4" jack connectors.

Pedal Input - for TC G-Switch

Two different modes can be set for the pedal Input: With the TC Electronic G-Switch pedal you are able to:

In mode A:

- Switch 1 - Preset up
- Switch 2 - Preset down
- Switch 3 - G-Sharp bypass

In mode B:

- Switch 1 - Bypass Effects Engine
- Switch 2 - Bypass Reverb Engine
- Switch 3 - Tap tempo

Selecting Modes

Press LOAD and PRESET ON/OFF at the same time. Then use the ARROWS to select between A and B.

TC G-Switch

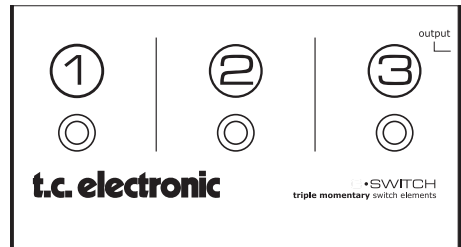

SIGNAL FLOW

G-Sharp

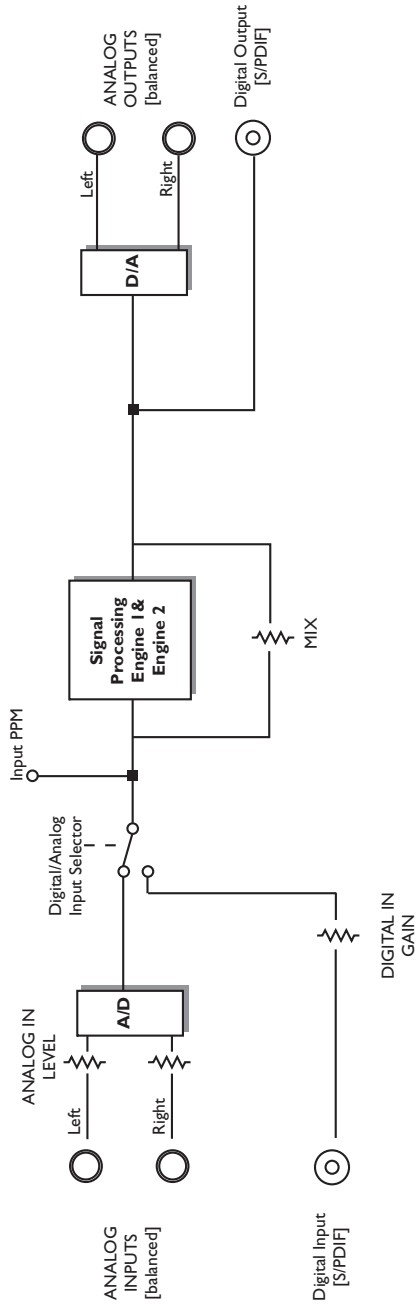

Connecting and Setting up the G-Sharp

Setting up the G-Sharp is very easy. It is, however, important to connect and setup the G-Sharp correctly according to your application. Setting up basically means: connecting, selecting one of the two routing options, selecting programs and finally setting the EFFECTS MIX and REVERB MIX on the front panel. Find the setup you are about to create or one that is similar to on the following pages - and follow the instructions.

Controlling G-Sharp

Preset Recall and Tap Tempo

A MIDI pedal can be used to recall the 99 user-presets and also tap in the Global tempo. Read more about the Global tempo and the Tap function later in this manual. A MIDI pedal should be connected to MIDI In and G-Sharp is per default set to receive MIDI information on Channel 1. This can be altered - See the manual section "MIDI".

If you only need to switch between relatively few presets and tap tempo we suggest either using the analog TC Electronic G-Switch or the TC Electronic G-Minor MIDI pedal. Of course other MIDI pedals can also be used. For full access to all G-Sharp features you should chose a MIDI pedal that can send both MIDI Control Change messages as well as MIDI program changes.

Expression pedals

Expression pedals can be used to control various parameters*.

On G-Sharp the obvious parameter to control would be In-Volume. The Expression pedal must be connected to and calibrated with your MIDI board.

* a complete list is found on page 27.

Routings

There are two routings to choose between: Serial and Parallel. The routing is selected using the switch on the front panel.

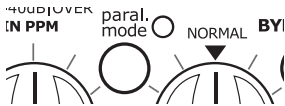

When the PARALLEL mode LED on the front panel is lit, G-Sharp is in Parallel mode. When the LED is "off", - G-Sharp is in Serial mode. The Routing is a global setting and cannot be saved and changed with presets.

Serial Routing

With this routing the signal is first routed through the Effects engine and then through the Reverb engine.

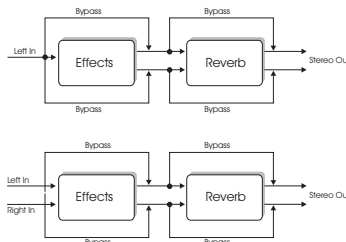

This is the Routing to select when you want to add reverb to the signal after the signal is processed

BASICS

by the Effects engine. Serial mode works perfectly for all effect combinations but if you are using relatively long and loud delay repeats you should consider whether you prefer to have reverb added to delay repeats or not. If you prefer the delay repeats to stand out very clear and still use reverb you may prefer the Parallel routing.

Parallel Routing (analog Input only)

This routing gives you the opportunity of having two effects in parallel, even on a single mono signal. The input signal is split and fed to both the Effects engine and the Reverb engine at the same time. Both the Effects engine and the Reverb engine uses left and right outputs as common outputs.

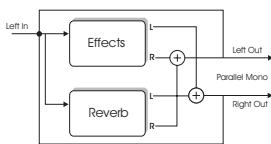
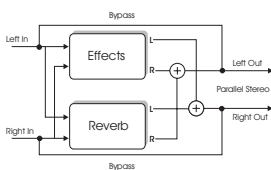

General advice

High quality cables

Good cables are essential! We advice that you use properly shielded cables of high quality throughout your entire setup, but be aware that one of the most sensitive points is the cable going from your guitar to the first piece of equipment. Especially if you are using a guitar with passive single coil pickups such as a Stratocaster. The few extra bucks for good quality cables are well spent.



You cannot connect a guitar directly to the G-Sharp inputs. Always insert a preamp, pedal or similar piece of equipment between the guitar and the G-Sharp.

Level settings

Correct level settings in all audio equipment are essential to get best performance from AD and DA converters and as little noise as possible. Therefore you should follow the advice on setting Input level as described on page 16.

TYPICAL SETUPS

Serial Setup

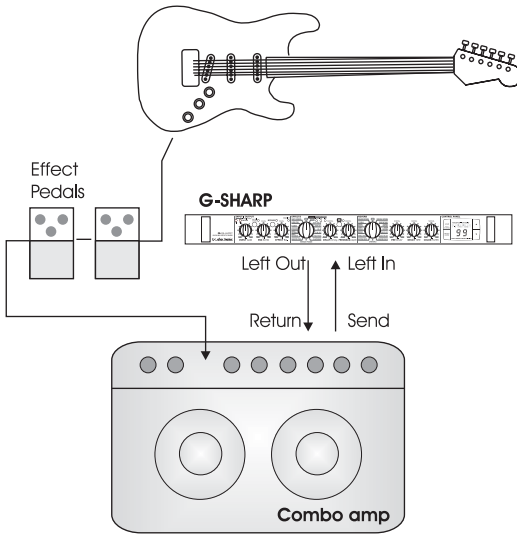

In this setup the G-Sharp is connected to the effects loop of an amplifier.

- Connect guitar to drive pedals, wah etc. and into the amps input.
- Connect the effect loop send to the left input of the G-Sharp.
- Connect the G-Sharp left output to the return of the amplifier.
- Set Routing to serial or parallel.
- Set Input level to 12 o'clock position.
- Set EFFECTS MIX to 12 o'clock position.
- Set REVERB MIX to 12 o'clock position.
- Adjust/fine-tune the G-Sharp Input level so the Input LED on the front panel often is yellow but only rarely peaks at Red color.
- Select Effects and Reverb type using the selectors on the front panel.
- Now fine-tune EFFECTS and REVERB mix as well as parameters.

The setup is mono but could be expanded to stereo if the Right output of the G-Sharp is connected to a separate amp.

TYPICAL SETUPS

Head + cab

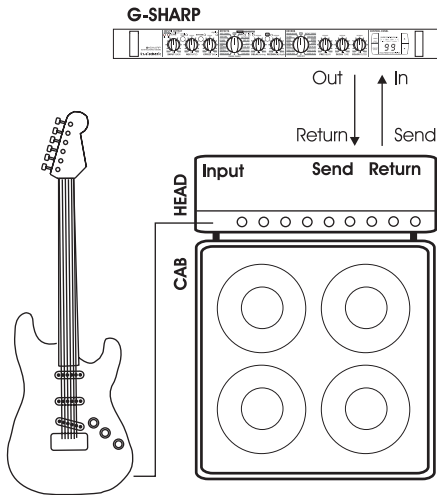

This is a basic setup if you are using a conventional head with serial loop.

- Connect the guitar to the input of the head.
- Connect the effect loop send to the G-Sharp left input and the G-Sharp left output to the effect loop return of the amplifiers.
- Set Routing to serial or parallel.
- Set INPUT to 12 o'clock position.
- Set EFFECTS MIX to 12 o'clock position.
- Set REVERB MIX to 12 o'clock position.
- Adjust/fine-tune the G-Sharp Input level so the Input LED on the front panel often is yellow but only rarely peaks at red color.
- Select reverb type and Effects type using the selectors on the front panel.
- Now fine-tune EFFECTS and REVERB mix as well as parameters.

You can of course add effect pedals in front of the head as you wish.

The setup is mono but could be expanded to stereo if the right output of the G-Sharp is connected to a separate amp.

TYPICAL SETUPS

Preamp + combo

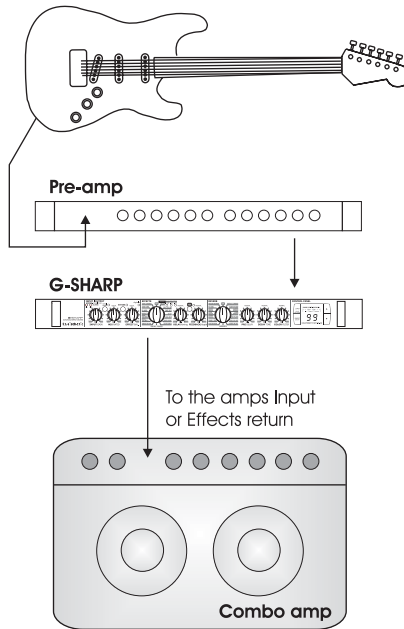

This is a basic setup if you are using a preamp separate from the one in your amp.

- Connect the guitar to the input of the pre-amp.
- Connect the pre-amps output to the G-Sharp input and the G-Sharp output to either the input or the effects return on your amplifier.
- Set Routing to serial or parallel.
- Set Input level to 12 o'clock position.
- Set EFFECTS MIX to 12 o'clock position.
- Set REVERB MIX to 12 o'clock position.
- Adjust/fine-tune the G-Sharp Input level so the Input LED on the front panel often is yellow but only rarely peaks at red color.
- Select Reverb type and Effects type using the selectors on the front panel.
- Now fine-tune EFFECTS and REVERB mix as well as parameters.

The setup is mono but could be expanded to stereo if the right output of the G-Sharp is connected to a separate amp.

You can of course add effect pedals in front of the preamp as you wish.

TYPICAL SETUPS

Preamp + power amp

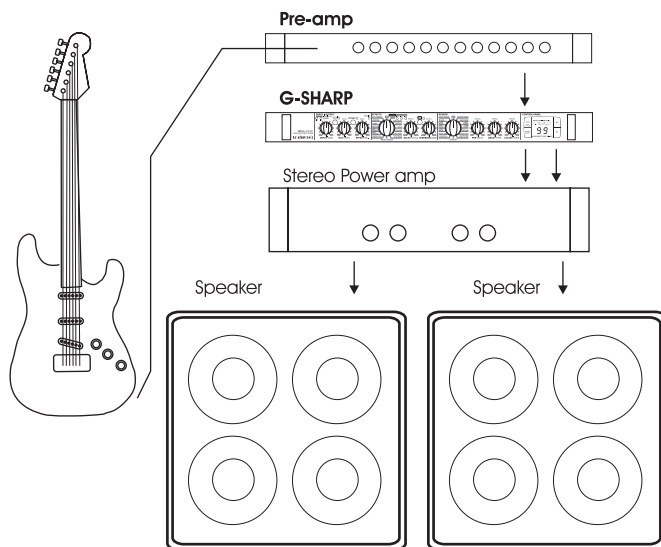

This is a basic setup if you are using a separate power amp for a stereo setup.

- Connect the guitar to the Input of the pre-amp.
- Connect the pre-amps output to the G-Sharp input and the G-Sharp outputs to the input of the stereo amplifier.
- Set Routing to serial or parallel.
- Set Input level to 12 o'clock position.
- Set EFFECTS MIX to 12 o'clock position.
- Set REVERB MIX to 12 o'clock position.
- Adjust/fine-tune the G-Sharp Input level so the Input LED on the front panel often is yellow but only rarely peaks at Red color.
- Select Reverb type and Effects type using the selectors on the front panel.
- Now fine-tune EFFECTS and REVERB mix as well as parameters.

You can of course add effect pedals in front of the preamp as you wish.

OPERATING - INPUT/OUTPUT SECTION

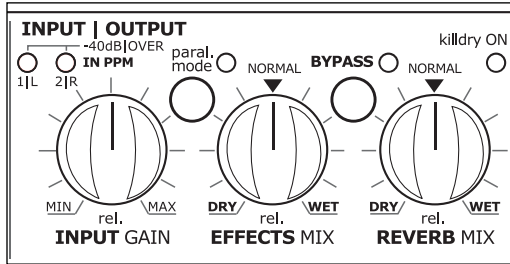

INPUT GAIN & 1/L-2/R INPUT LEDs

This knob controls the input level for both the analog and digital input options. A correctly set input level is essential to achieve optimal performance with least possible noise.

To set the Input level:

Clean sounds have the most dynamics. Play powerful chords with the loudest clean sound you use and adjust the Input Gain accordingly.

The Input LEDs indicate the level using three colors.

- Green : -40dB - You are "well on the safe side".
- Yellow : -6dB - You are close to optimal performance.
- Red : -1dB - Red LED only blink occasionally at absolute peaks.

Analog Input Range

- Counter-clockwise : -10dB
- Center : 0dB
- Clockwise : +14dB

Digital Input Range

- Counter-clockwise : -18dB
- Center : 0dB
- Clockwise : +6dB

Parallel mode/(serial mode) LED and button

Press the switch to switch between Serial and Parallel modes. When this LED is lit (green) Parallel mode is selected. When the LED is not lit - Serial mode is selected.

EFFECTS MIX

Adjusts the mix between the wet and the dry signal for the Effects engine.

REVERB MIX

Adjusts the mix between the wet and the dry signal for the Reverb engine.

BYPASS LED

When the LED is lit, G-Sharp is in bypass mode. The bypass function operates differently depending on whether you are in Killdry mode or not.

Killdry "on":

The BYPASS key operates as a mute function.

Killdry "off":

The bypass function simply passes the source signal unprocessed to output.

Killdry ON LED

Killdry mode is selected on the rear panel. When it is selected, no clean signal passes through the G-Sharp. This is the setting to use if you connect G-Sharp in a parallel loop or e.g. in an aux send/return on a mixer.

THE EFFECTS ENGINE

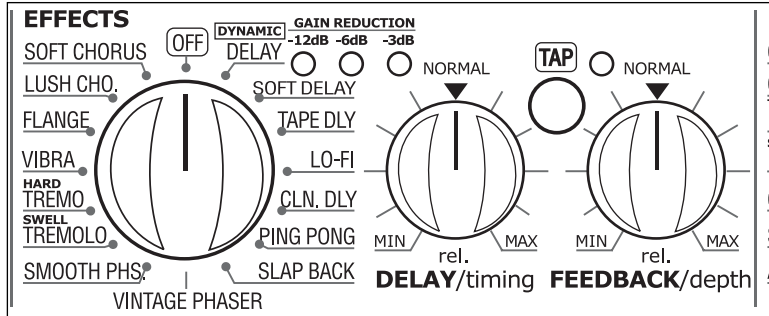

Effects engine

Effect Selector

With the EFFECTS selector you select between one of the following effects and Off.

- Dynamic Delay
- Soft Delay
- Tape Delay
- Lo-Fi Delay
- Clean Delay
- PingPong Delay
- SlapBack Delay
- Vintage Phaser
- Smooth Phaser
- Swell Tremolo
- Hard Tremolo
- Vibrato
- Flange
- Lush Chorus
- Soft Chorus

-12dB, -6dB, -3dB Gain Reduction LEDs

These LEDs indicate the applied gain reduction on the delay repeats when the Dynamic Delay is selected. - The purpose of the Dynamic Delay is to reduce the level of the delay repeats while you play and increase the level of the repeats in-between phrases. This is a classic “ducking function” from the legendary TC2290.

TAP key and TIMING knob

Delay Effects:

The tempo of the Delay effects is set using both the TAP key and the TIMING knob. By tapping the TAP key you set a “global tempo” that you can increase/decrease using the TIMING knob.

With the TIMING knob in 12 o'clock position the tapped tempo equals 1/4 notes. With the TIMING knob in fully counter-clockwise position (min), the delay time is multiplied by 0.5 thus giving half the tapped tempo. With the TIMING knob in fully clock-wise position (max), the delay time is multiplied by 2 giving the double delay time.

Example

Let us say that you tap quarter notes in tempo 120BPM using the TAP key. With the TIMING knob in 12 o'clock position you now have a Delay time of 500ms*.

If you turn the TIMING knob fully counter-clockwise the actual Delay time will be 0.5 times 500ms= 250ms

If you turn the TIMING knob fully clockwise the tempo will be:
2 times 500ms=1000ms (1 second)

When powering up the G-Sharp the default tempo is 120BPM, but as explained above the position of the TIMING knob defines the actual tempo.

*The nature of a Slapback Delay is very short delay times and the range of this delay type is therefore much shorter with this delay type selected.

THE EFFECTS ENGINE

TIMING knob - Chorus, Flanger, Phaser and

Tremolo:

Increases/decreases the Tempo.

Remember that the default setting suggested by TC Electronic is achieved by setting the knob in 12 o'clock.

FEEDBACK/DEPTH

This knob changes functionality with the selected algorithms.

The knob controls the Feedback parameter in:

All Delays

The knob controls the Depth parameter in:

Chorus

Flanger

Phaser

Tremolo

For further details on these parameters please read chapter explaining all effect parameters.

THE REVERB ENGINE

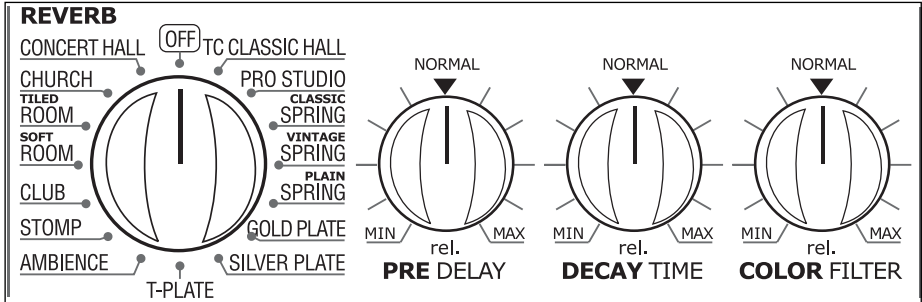

Reverb engine

Reverb Selector

Select between the following Reverb types or "Off".

- TC Classic Hall
- Pro Studio
- Classic Spring
- Vintage Spring
- Plain Spring
- Gold Plate
- Silver Plate
- Tin Plate
- Ambience
- Stomp
- Club
- Soft Room
- Tiled Room
- Living Room
- Church Room
- Concert Hall

To hear the carefully designed default settings for each of the reverb types set PRE DELAY, DECAY and COLOR knobs in "12 o'clock" position (neutral). Then adjust and fine-tune to the given application.

It is worth noticing that the range of each of these parameters will vary from algorithm to algorithm.

As an example it is possible to set a much longer decay time for a Gold Plate or TC Classic Hall than for e.g. Ambience.

Pre Delay

A short delay placed between the direct signal and the Reverb diffuse field. By using pre-delay, the source material is kept clear and undisturbed by the reverb diffuse field arriving shortly after.

Decay

The decay parameter determines the length of the reverb diffuse field. The length is defined as the time it takes for the reverb to decay approximately 60dB.

Color

Varies the "color" of the reverb. From dark to crisp and bright the color parameter can really change the characteristics and style of the reverb.

STORE - RECALL & THE G-SHARP DISPLAY

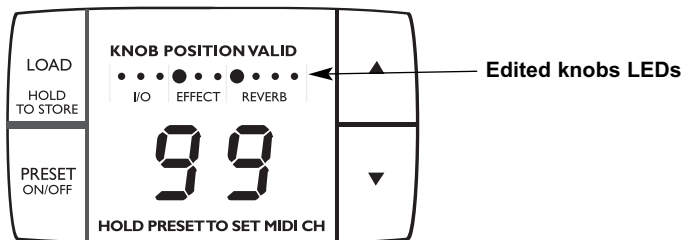

Preset Modes

The G-Sharp holds two significantly different modes. To toggle between these modes press the PRESET ON/OFF key.

“Preset On” mode

In this mode it is possible to load any of the previously stored presets. The “Preset On” mode is active when the display shows location numbers from 1 to 99.

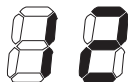

If you try to load a preset from a location where no preset is stored - no action will take place.

“Preset Off” mode

In Preset Off mode the G-Sharp will process the signal according to the position of the front controls. A “what you see is what you hear” - setting.

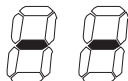

Once you have accessed the Preset Off mode and return to the Preset On mode the preset number will blink indicating that you must press LOAD to recall the settings stored with that particular preset.

Display

Edited knobs LEDs

(relevant only in “Preset On” mode)

These LEDs refer to the 9 front panel controls. See illustration above. (no LED for the INPUT knob).

When the LEDs are lit they indicate when the front controls match the current settings of the active preset.

When changing the position of a knob the corresponding LED is off/unlit.

Load/Store Presets

Load User Preset

- Enter “Preset On” mode using the PRESET ON/OFF key. The G-Sharp is in Preset On mode when the display shows location-numbers 1 to 99. Use the UP/DOWN arrows to select the desired preset (1-99).
- The digits are now blinking to indicate that you are previewing the preset and it has not yet been recalled.
- Press LOAD to recall the preset and the digits are now steady.

Store User Preset

- Enter “Preset On” mode using the PRESET ON/OFF key. The G-Sharp is in Preset On mode when the display shows location-numbers 1 to 99.
- Use the UP/DOWN arrows to select desired preset location where you intend to store the preset (1-99).
- The digits are now blinking to indicate that you have not yet stored the preset.
- Press and hold the LOAD (HOLD TO STORE) key for approx. 2.5 seconds until the digits turn steady.

MISCELLANEOUS

MIDI

MIDI CH.

Via an external MIDI device it is possible to recall presets and control parameters in the G-Sharp. For the external device to communicate with the G-Sharp it is essential that they communicate on the same MIDI Channel. The G-Sharp can be set to receive on any of the 16 MIDI channels, none or all.

- Press and hold PRESET ON/OFF. The current selected MIDI channel is displayed.

Assuming the G-Sharp is “right out of the box” or that you have performed a Reset procedure as described on page 27, the display now shows:

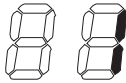

- indicating that channel 1 is selected and the G-Sharp can receive MIDI information on channel 1.

- Use the UP/DOWN arrows to select MIDI channels 1 to 16.
- “O” indicates Omni mode, which means that the G-Sharp can receive MIDI information on all channels.
- “OF” indicates that the G-Sharp will ignore any incoming MIDI messages.
- Press LOAD to verify and exit menu.

SysEx ID

The G-Sharp SysEx ID is always identical with the set MIDI Channel.

External MIDI editor mode

Via MIDI, all parameters can be controlled via an external software Editor. For the G-Sharp to respond to the editor commands the G-Sharp must be in “Editor mode”.



When the G-Sharp is controlled via the external software editor, the front-panel controls are locked and cannot be used to alter parameter values.

Factory Presets

The G-Sharp holds no conventional factory presets. When all the controllers are in 12 o'clock position the G-Sharp is in “neutral”, meaning that all parameters are set as suggested by TC Electronic. However, by combining the 16 positions of both the Effects and Reverb selectors you actually have 256 “factory” presets.

Application Software version

This number indicates the currently loaded application software and is relevant for servicing purposes only.

- Press and hold PRESET ON/OFF and use the UP/DOWN arrows to select “AP” as displayed below.



The display will flash between “AP” (for application) and the current loaded application software.

Front Software version

This number indicates the current loaded front software and is relevant only for servicing purposes.

- Press and hold PRESET ON/OFF and use the UP/DOWN arrows to select “Fr” as displayed below.

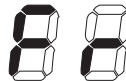

The display will flash between “Fr” (for front-software) and the current loaded front software number.

EFFECTS

This manual section explains the function of the front panel controls as well as the algorithm parameters in the Effects engine.

Delay - controls

DELAY/TIMING knob

Both the TIMING and the TAP keys are used to specify the desired tempo of the repeats. A tempo is tapped on the TAP key and with the TIMING knob you multiply this tempo. The range of the TIMING knob is 0.5 to 2.

FEEDBACK/DEPTH knob

The FEEDBACK knob sets the number of Delay repeats. Leaving the knob in 12 o'clock position gives you the starting point suggested by TC Electronic.

Delay Types

Dynamic Delay

The Dynamic Delay initially introduced in the renowned TC 2290 is a Delay type that allows the Delay output level to be actively altered by the dynamics of the input level.

A function that can be used to leave the source material clear and undisturbed while played and delicately accompanied by the Delay between phrases.

Soft Delay

Whereas the "Clean Delay" gives a perfect reproduction of the source material, the Soft Delay rolls of the high-end frequencies slightly given you delay repeats with less edge that very often blends better and sounds more natural in the mix.

Tape Delay

This algorithm emulates the old style Tape Delays. Before the digital era delays were created using a Tape Recording device with a tape-loop and recording/playback heads. As you probably know analog tape-recorders has a tendency to deteriorate/change the recorded material. Wow and flutter combined with a significant loss of high-end frequencies, and to some extent also low-end frequencies, are all elements commonly associated with tape recordings. These features, that on paper sound negative, are often quite useful and sought-after as they tend to blend with and compliment the source material in a highly

musical manner. Among other things the G-Sharp Tape Delay uses a HiCut with a rather low Cross-over frequency to emulate the loss of highs found on conventional Tape delays. Compare the Tape Delay to the Clean Delay algorithm to hear the difference and experiment.

Lo-Fi

Deliberately squashing the sound of the delay repeats, the Lo-Fi delay effect allows you to make a statement.

Clean Delay

Standard Delay. The G-Sharp processing power and excellent 24 bit converters will process a precise high quality Delay with no deterioration of the sound.

PingPong Delay

The PingPong Delay basically pans the delay repeats from left to right and back while keeping the Input signal at its original position. This gives a very wide spread special effect.

Slapback Delay

Slapback Delay is a very short delay with only a single or a few repeats. The effect is commonly used as a "doubling-effect" making the processed material seam more massive. Short slapback delays are also often used on funky rhythm guitars, - a bit longer on Rockabilly guitar or vocals.

Delay spillover feature

All delays feature a "spillover" feature – meaning that the repeats of the delay can ring out when you change presets. However, for this to work, the preset you changing to must also include a delay.

Example:

You play with a preset with a long delay time, e.g. a solo. When you change to a rhythm preset with a shorter or no delay, it will most often sound more natural and make the preset change seamless letting the long delay repeats ring out even though the preset has already changed.

Phaser

Vintage Phaser

The Vintage Phaser utilizes four all-pass filters. These filters create comb-looking characteristics. When the filtered sound is mixed with the direct sound the “phasing sound” occurs.

Smooth Phaser

Where the Vintage Phaser utilizes 4 all-pass filters the Smooth Phaser uses an 8 all-pass filter structure. This gives a much smoother and subtle phasing sound.

Phaser - controls

DELAY/TIMING knob

In the Phaser algorithm the TIMING knob sets the speed of the Phaser.

FEEDBACK/DEPTH knob

In the Phaser algorithm the FEEDBACK/DEPTH knob sets the depth of the phasing effect.

Tremolo

Hard Tremolo/Swell Tremolo

A Tremolo is basically a repeated level change controlled by an LFO. The G-Sharp offers a Hard Tremolo that used a “square” wave-shape and Swell Tremolo that use a “triangular” wave shape. Please see the illustration below. The difference is quite obvious. Listen and enjoy!

Hard Tremolo - Square shape



Swell Tremolo - Triangular shape



Tremolo - controls

DELAY/TIMING knob

In the Tremolo algorithm the TIMING knob sets the speed of the Tremolo.

FEEDBACK/DEPTH knob

In the Tremolo algorithm the FEEDBACK/DEPTH knob sets the depth of the Tremolo effect.

Vibrato

An effect deriving from minute and rapid variations in pitch. This is the classic expression know from many vocalists.

Chorus

A Chorus/Flanger is basically a short Delay that is modulated by an LFO (Low Frequency Oscillator).

The modulation of the short Delay gives very small variations in pitch. These pitch changes blended with the direct sound gives you the Chorus/Flanger sound.

A Chorus effect is typically used as a smoothing effect.

Soft Chorus/Lush Chorus

The Soft Chorus is ideal for silk-smooth softening of the signal. The Lush Chorus is a better choice for more significant and hearable chorus sounds.

Flange

The basics of the flanging sound are identical to the chorus (see above), but the delay time is longer and the feedback control has a wider range.

Where the chorus typically is used as a smoothing effect the Flanger is more in the genre of “special effects”.

Chorus/Flanger - controls

DELAY/TIMING knob

In the Chorus/Flanger algorithms the TIMING knob sets the speed of the effect.

FEEDBACK/DEPTH knob

In the Chorus/Flanger algorithm the FEEDBACK/DEPTH knob sets the depth of the effect.

REVERBS

The G-Sharp holds the following Reverb types:

- TC Classic Hall
- Pro Studio
- Classic Spring
- Vintage Spring
- Plain Spring
- Gold Plate
- Silver Plate
- T-Plate
- Ambience
- Stomp
- Club
- Soft Room
- Tiled Room
- Church
- Concert Hall
- Off

Each of these Reverb types are created and fine tuned by the highly experienced staff at TC Electronic and utilizes the vast experience we have accumulated over the past years of producing high quality reverbs. Though the G-Sharp is a very compact effects unit in the affordable price range, there is no compromise when it comes the Reverb quality.



To get best starting points for your application set the three controls in the Reverb engine at 12 o'clock position and "take a trip" round the different reverb types.

By leaving the controls in 12 o'clock position you will hear our suggested settings for each Reverb type.

Once you have the Reverb type closest to your goal start twisting the controls.

Pre Delay

A short Delay placed between the direct signal and the Reverb Diffuse field. By using Pre Delay the source material is kept clear and undisturbed by the more diffuse Reverb Diffuse Field arriving shortly after.

Decay

The Decay parameter determines the length of the Reverb Diffuse Field. The length is defined as the time it takes for the Diffuse Field to decay approximately 60dB.

Color

Varies the "color" of the Reverb. From dark to crisp and bright the Color parameter can really change the characteristics and style of the Reverb. Try it!

Perception of Reverb types may vary from person to person. It is a rather subjective issue to discuss, describe or even define. However, over the years a general perception of basic Reverb types has evolved. From these definitions the experienced sound-engineer chooses and is given good starting points for various applications. We choose to briefly describe the Reverb types found in the G-Sharp like this:

TC Classic Hall

The reverb from many legendary TC products that gives you a rich spacious feel with plenty of air. Perfect with medium to long decay times. Play with the color parameter to find the correct blend. If you feel you have the correct mix level but the reverb is not significant enough still, - try increasing the high colors.

Pro Studio

A neutral generic studio reverb with very limited modulation on the decay diffuse field. Where many of the other reverb types are tuned to stand out in a live environment, the Pro Studio is a subtle reverb that excels in recording situations where details in the source material are the primary focus.

Classic Spring

With the Classic Spring reverb you've got one of the best emulation of a classic spring reverb there is. We've spent a lot of time calculating and reinterpreting the behavior of a traditional spring reverb.

Vintage Spring

The Vintage Spring emulates the spring reverb types found in old guitar-amps. It is a bit more grindy compared to the Classic spring and gives a very realistic old-school sound.

Plain Spring

This reverb type is the least colored spring emulation included in the G-Sharp. Compared to the Classic Spring and Vintage Spring types, Plain Spring appears as the most neutral of the three.

REVERBS

Gold Plate

We've boosted the full potential of the plate reverbs of the past, and designed the Gold Plate algorithm to reflect all the brightness, coloring and diffusion that the original plate reverbs had to offer. Use this reverb when you just can't get "gold" enough on your sound.

Silver Plate

The Silver Plate algorithm is a luxuriously well-tempered plate reverb, which gives you a perfect balance between the Tin and Gold Plate reverbs. It's got all the qualities of a classic plate reverb, the right amount of exquisite and gentle coloring with crystalline brightness and subtle diffusion. Use this reverb for just about anything, and especially when you want to add that complete and personal ambience.

Tin Plate

We have done our best to recreate the plate reverbs used before the digital era. The Tin Plate reformulates the sound of a large metallic plate, and gives you a sound that you probably heard on many recordings from the past. Use the Tin Plate when you just want the pure and uncolored plate sound. It is bright and has a diffuse quality that is perfect for funky rhythm guitar patterns.

Ambience

With focus on the Early Reflections that defines the perception of a room size, the Ambience Reverb type is typically used on dry recordings simply to emulate a feeling of environment. Ambience and Room definition are the keywords here.

Stomp

Quite an extraordinary reverb type reproducing some of the characteristics from contemporary stomp-box reverbs. This is not a smooth subtle reverb but may be just what you are looking for if you need a reverb that is different and can cut through.

Club

Did you ever discover the great difference of a sound-check and the actual concert? The Club Reverb emulates a typical empty medium sized club. Try this as an effect that will emphasize and position the guitar rather than give it a big sigh.

Soft Room

A room type that simulates a relatively small room well furnished. In such a room many reflections are absorbed by soft material and source material is reflected and sustained only from walls and windows etc. The sound is short, dry, and quite intimate.

Tiled Room

Often you'll want to get the "bathroom" effect, without actually wanting it to sound like you're playing in your bathroom. The Tiled Room reverb simulates the qualities of a small to medium size tiled room with its many reflections and at the same time it behaves respectfully towards the original source material. Use it as an effect that adds quite a bit of color to your sound.

Church

A highly diffuse reverb that is recognizable for its emulation of the many hard surfaces of different shapes found in traditional church rooms.

Concert Hall

This reverb has become a classic in itself. It simulates a rather large hall and it's stunningly good at preserving the original and natural characteristics of the source material. If you're looking for a sound with long decay times the Concert Hall is excellent and you'll get a large and broad sound that is very distinctive.

APPENDIX - MIDI IMPLEMENTATION CHART

DUAL ENGINE PROCESSOR G-Sharp - MAY 2006

Function		Transmitted	Recognized	Remarks
Basic Channel	Default	1	1	
	Changed	1-16	OMNI-1-16	
Mode	Default			
	Messages	X	X	
	Altered			
Note Number		X	X	
	True Voice	X	X	
Velocity	Note ON	X	X	
	Note OFF	X	X	
After Touch	Key's	X	X	
	Channel	X	X	
Pitch Bend		X	X	
Control Change		O	O	See CC list on page 27 for details. All Controllers are Single Byte type scaled to parameter range.
Prog Change		O	O	
SysEx		O	O	
Common	Song Pos	X	X	
	Song Sel	X	X	
	Tune			
System real time	Clock	X	O	MIDI TimeClock can be used to set Delay tempo.
Aux Messages	Commands	X	X	
	Local ON/OFF	X	X	
	All Notes OFF	X	X	
	Active Sense	X	X	
	Reset	X	X	

O: YES Mode 1: OMNI ON, POLY Mode 2: OMNI ON, MONO
X: NO Mode 3: OMNI OFF, POLY Mode 4: OMNI OFF, MONO

APPENDIX - MIDI CC & RESET & BULK DUMP

MIDI Continuous Controllers

Via an external MIDI device sending MIDI Control Changes you are able to control the parameters listed below.

Parameter **Control Change number:**

In Level	12
Effects Mix	13
Reverb Mix.	14
Digi. In	15
Bypass	81
Effects. Type	50
Effects. Off	82
Timing	16
Tap	80
Feedback	17
Rev. Type	51
Rev. Off	83
PreDelay	18
Decay	19
Color	20

MIDI Bulk Dump

By performing a MIDI bulk dump you are able to dump all presets to an external MIDI device such as a sequencer for backup.

- Press and hold the PRESET ON/OFF key approx. 2.5 sec.
- Use the ARROW UP/DOWN keys to select Bulk Dump mode.

The display will show:

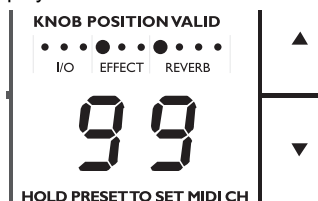

- Set the receiving device in MIDI bulk receive mode. A standard MIDI sequencer program should typically be set to record a MIDI track. (Please refer to the user manual of the receiving device).
- Now press LOAD once, and the MIDI Bulk Dump is performed.



The G-Sharp is always ready to receive a MIDI bulk dump unless the receive MIDI channel is set to off "OF"

Reset Procedure

If you would like to do a complete reset of the G-Sharp and return to factory settings follow this procedure:

- Power down by disconnecting the power cord.
 - Press and hold TAP while re-connecting power. The display will show a flashing "R".
 - Press LOAD to reset.
 - Power off - power on.
- The unit is now reset.



Be aware that all user presets will be lost when performing a factory reset!

TROUBLESHOOTING

Weird flanging sound when connected in a parallel effects loop

When using any effects processor in an effects loop it is essential that the loop is either 100% serial or that you use the G-Sharp killdry function. Killdry is activated using the switch on the rear panel.

The reason for this is that any digital processing unit has a slight delay (G-Sharp has less than 2ms), and when a slightly delayed dry signal is mixed with an unprocessed signal a flanging/phased type sound occurs. In that case it definitely seem as if the G-Sharp is coloring your sound in a highly unintended way.

You can test the effect loop of most amp types by inserting a jack cable to the send of the preamp. The signal should be muted 100%.

If your loop is a parallel type it probably has a mix knob, or built in mix function if it is a MIDI preamp. In that case we suggest using the G-Sharp killdry function. You can then control the amount of effect using the amps loop mix-control and the EFFECTS and REVERB mix controls on the G-Sharp.

No response when using a MIDI pedal

Ensure that the MIDI pedal is sending on the same channel as the G-Sharp is set to receive on. The default MIDI channel for G-Sharp is "1". Refer to this manual's section on MIDI to learn how to change MIDI channels.

APPENDIX - TECHNICAL SPECIFICATIONS

Digital Input and Output

Connector:	RCA Phono (S/PDIF)
Formats:	S/PDIF (24 bit), EIAJ CP-340, IEC 958
Sample Rates:	44.1 kHz, (48 kHz only @ Digital Input)
Processing Delay:	0.08 ms @ 48 kHz
Frequency Response DIO:	DC to 23.9 kHz \pm 0.01 dB @ 48 kHz

Analog Inputs

Connectors:	1/4" phone jack balanced, mono sense
Impedance, Bal / Unbal:	21 kOhm / 13 kOhm
Max. / Min. Input Level @ 0 dBFS:	+24 dBu / 0 dBu
Sensitivity Range @ 12 dB headroom:	-12 dBu to +12 dBu
A to D Conversion:	24 bit, 128 x oversampling bitstream
A to D Delay:	0.70 ms / 0.65 ms @ 44.1 kHz / 48 kHz
Dynamic Range:	typ < -92 dB, 22 Hz to 22 kHz
THD:	typ < -90 dB (0.0032 %) @ 1 kHz, -1 dBFS
Frequency Response:	+0/-0.1 dB, 20 Hz to 20 kHz
Crosstalk:	typ < -100 dB, 20 Hz to 20 kHz

Analog Outputs

Connectors:	1/4" phone jack balanced
Impedance Bal / Unbal:	40 Ohm / 20 Ohm
Max. Output Level:	+14 dBu
D to A Conversion:	24 bit, 128 x oversampling bitstream
D to A Delay:	0.68 ms / 0.63 ms @ 44.1 kHz / 48 kHz
Dynamic Range:	typ < -105 dB typ, 22 Hz to 22 kHz
THD:	typ < -97 dB (0.0014 %) @ 1 kHz, +13 dBu
Frequency Response:	+0/-0.5 dB, 20 Hz to 20 kHz
Crosstalk:	typ < -100 dB, 20 Hz to 20 kHz

EMC

Complies with:	EN 55103-1 and EN 55103-2 FCC part 15, Class B, CISPR 22, Class B
----------------	--

Safety

Certified to:	IEC 65, EN 60065, UL6500 and CSA E60065 CSA FILE #LR108093
---------------	---

Environment

Operating Temperature:	32° F to 122° F (0° C to 50° C)
Storage Temperature:	-22° F to 167° F (-30° C to 70° C)
Humidity:	Max. 90 % non-condensing

Control Interface

MIDI:	In/Out: 5 Pin DIN
Pedal:	1/4" phone jack

General

Finish:	Anodized aluminum front Plated and painted steel chassis
Display:	2 x 7 segment + LED's
Dimensions:	19" x 1.75" x 4.2" (483 x 44 x 105.6 mm)
Weight:	3.3 lb. (1.5 kg)
Mains Voltage:	100 to 240 VAC, 50 to 60 Hz (auto-select)
Power Consumption:	<15 W
Warranty Parts and labor:	1 year

Due to continuous development these specifications are subject to change without notice.